

Enzyme-Mediated Catalytic Asymmetric Oxidations

Stefano Colonna,¹ Simone Del Sordo,¹ Nicoletta Gaggero,¹
Giacomo Carrea,² and Piero Pasta²

¹*Istituto di Chimica Organica, Facoltà di Farmacia, via Venezian 21, 20133 Milano, Italy*

²*Istituto di Chimica Del Riconoscimento Molecolare CNR, via Mario Bianco 9, 20131 Milano, Italy*

Received 22 June 2001; revised 11 April 2002

ABSTRACT: *Enantiomerically pure sulfoxides are excellent chiral auxiliaries for asymmetric synthesis and in the preparation of several enantiopure biologically active compounds. We have explored biocatalytic approaches based on the use of heme peroxidases and flavin monooxygenases such as chloroperoxidase and cyclohexanone monooxygenase respectively. By using isolated enzymes or whole-cell biotransformations, we have prepared alkyl aryl sulfoxides, 1,3-dithioacetal-1-oxides, dialkyl sulfoxides, and thiosulfonates in high enantiomeric excess. An active site model of cyclohexanone monooxygenase has been proposed in order to explain and to predict the absolute configuration of the product.* © 2002 Wiley Periodicals, Inc. *Heteroatom Chem* 13:467–473, 2002; Published online in Wiley InterScience (www.interscience.wiley.com). DOI 10.1002/hc.10074

INTRODUCTION

Recent experiments from our as well as other laboratories have shown that chloroperoxidase (CPO) is able to catalyze a broad spectrum of stereoselective epoxidation reactions. The substrate repertoire includes substituted styrenes, as well as straight chain

aliphatic and cyclic cis-olefins. The enzyme is also able to perform benzylic hydroxylation of alkynes with high enantiometric excesses (ees).

The enormous synthetic potential of monooxygenases, such as the ubiquitous cytochrome P-450, is well recognized. In vivo these enzymes catalyze the insertion of an oxygen atom, derived from molecular oxygen, into a large variety of organic substrates, often with a high degree of chemo, regio, and stereoselectivity. However, P-450 monooxygenases suffer from several drawbacks; they require a stoichiometric amount of the NADP(H) cofactor that must be regenerated for economic reasons in large-scale applications. This problem can be circumvented by using whole-cell systems, but this often leads to competing reactions that lower the enantioselectivity and the chemical yield of the oxidation reaction. Furthermore, they show low stability and turnover rates and are difficult to isolate, thus preventing their industrial applications. Heme peroxidases are also versatile catalysts that perform oxidative reactions of numerous substrates [1] by using clean oxidants such as hydrogen peroxide or organic peroxides without the need of expensive cosubstrates. They are structurally and mechanistically related to the P-450 enzymes and have the protoporphyrin IX prosthetic group in common. In their natural function, peroxidases generally perform one-electron rather than two-electron oxidation of substrates such as phenols or aromatic amines. In this paper, we focus on the recent advances in the use of horseradish peroxidase (HRP) and CPO as heme peroxidases. We also

Correspondence to: Stefano Colonna; e-mail: stefano.colonna@unimi.it.

Contract grant sponsor: CNR, MURST Programma di Ricerca Scientifica di Interesse Nazionale.

Contract grant sponsor: Cost Programma.
© 2002 Wiley Periodicals, Inc.

discuss some relevant synthetic applications of cyclohexanone monooxygenase (CHMO) from *Acinetobacter*, a flavin containing monooxygenase.

In typical peroxidases a ferriprotoporphyrin IX is the prosthetic group, and the imidazole is the fifth (proximal) ligand of the iron atom. In the catalytic cycle, hydrogen peroxide binds to the ferric ion and its fast reduction to water leads to an oxoferryl species designated as compound **I**, which has a porphyrin radical cation structure (Fig. 1).

Compound **I** extracts an electron from the substrate to form compound **II** as the second intermediate. A second one-electron transfer returns the enzyme to the resting state. Compound **II** can, in its turn, react with H_2O_2 to give compound **III**, which is believed to be a dead-end species, or that is catalytically inactive [2]. The free radicals produced in the reaction may be subjected to coupling, disproportionation, and other nonenzymatic pathways, which are characteristics of each substrate.

According to the crystal structure of HRP isozyme C, the heme group is sandwiched between the distal and proximal domain of the enzyme, and there are two Ca^{++} binding sites [3]. The key catalytic residues for a series of peroxidases, namely Arg 38 and His 42, are highly conserved and have a similar disposition. The distal pocket, thus confirms the expectations for the proposed mechanism for compound **I** formation.

According to this mechanism, a basic amino acid residue (histidine) abstracts a proton from the hydroperoxide with a concomitant involvement of a positively charged amino acid (arginine) to assist the heterolytic cleavage of the oxygen–oxygen bond, with the formation of compound **I**.

A common feature of peroxidase is a protected heme group, not easily accessible to the substrate and exposed heme edge close to heme meso C20 and heme methyl C18.

Enantiopure sulfoxides are important building blocks in the organic synthesis of natural products because of their powerful stereodirecting ability in the carbon–carbon bond formation [4]. The activity

of the sulfinyl group in the synthesis of drugs is exemplified by omeprazole, an antiulcer compound with \$4 billion in sales, and sulindac, a nonsteroidal anti-inflammatory drug as well as an inhibitor of tumoral cell growth.

We have been the first to use HRP as an enantioselective catalyst in the oxidation of alkyl aryl sulfides to the corresponding (S) sulfoxides with hydrogen peroxide as oxidant [5]. Asymmetric induction took place only with methyl phenyl and methyl p-substituted phenyl sulfides. The rather modest ees in the range of 30–68% were later substantially increased by Ortiz de Montellano by molecular engineering [6]. The Phe 41/Leu mutant of HRP also showed a higher turnover since the substitution of Phe by smaller Leu favored the access of the substrate to the ferryl oxygen of compound **I**, responsible for the peroxxygenase activity.

CPO, which is easy to obtain in quantity from the marine fungus *Caldariomyces fumago*, has proved to be a highly versatile catalyst to perform oxidative reactions of numerous substrates. In addition to one-electron oxidations and disproportionation of H_2O_2 , CPO also catalyses oxygen transfer reactions as in the formation of hypohalous acids from halides [7], the oxidation of indole to oxindole [8], the oxidation of amines to nitroso compounds [9], and benzylic [10] and propargylic hydroxylations [11]. It is an unusual peroxidase because it contains a cystein axial ligand of the heme instead of the classical imidazole ligand, thus resembling the P-450 enzymes and an iron atom more exposed than in any other peroxidase. This enzyme is therefore a heme peroxidase/cytochrome P-450 functional hybrid. The crystal structure shows that CPO folds into a tertiary structure dominated by eight helical segments [12]. It has been proposed that Glu 183 and a histidine residue in the distal pocket are involved in the compound **I** formation. The catalytic cycle of CPO is represented in Fig. 2.

The addition of hydrogen peroxide to the native enzyme gives the usual compound **I**. In peroxidase-like activity, compound **I** is transformed into compound **II** by one-electron abstraction and the subsequent reaction with a second molecule of substrate regenerates the native enzyme. In the catalase activity, reaction of compound **I** with a second mole of H_2O_2 gives dioxygen and the native enzyme. In the halogenation, the hypohalide intermediate, formed by reaction of compound **I** with halide ion, would act as a source of halogen. More important, in the monooxygenase pathway, the ferryl oxygen is transferred from compound **I** to the substrate to afford the oxidized product and the native enzyme. Oxidized forms of CPO are unstable in the presence of H_2O_2 . Maintaining a low hydrogen peroxide concentration,

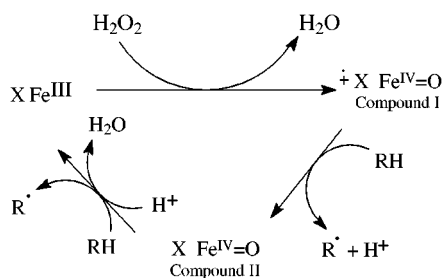

FIGURE 1 Catalytic cycle of peroxidase (X = porphyrin).

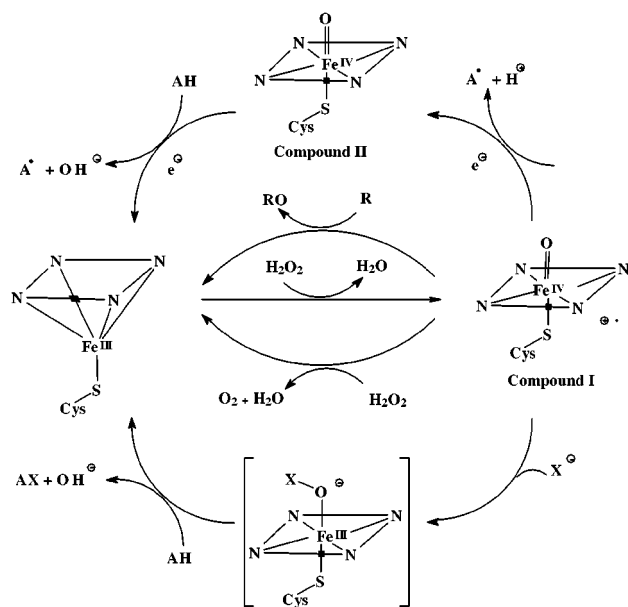

FIGURE 2 Catalytic cycle of CPO.

preferably by using a sensor-controlled feed-on-demand mode of addition [8], is essential to reduce the enzyme inactivation [13]. *tert*-Butyl hydroperoxide is less deleterious but reacts much slower with CPO than it does with H_2O_2 to form compound I.

CPO is the catalyst of choice for enantioselective oxygen transfer reactions such as sulfoxidation, hydroxylation, and epoxidation owing to its high activity and ready availability. We have been able to show that CPO is a very efficient catalyst, in terms of chemical and optical yields, for a large number of sulfides structurally related to phenyl methyl sulphide [14] (Table 1). Both the ee and the chemical yield are decreased by enlarging the size of the alkyl substituent at the sulfur atom or by introducing a substituent in the ortho position of the aromatic ring. Cyclic sulfides show a similar trend, 2,3-dihydrobenzo[b]thiophene is very efficiently oxidized in the presence of CPO, but 1-thiochroman gives the corresponding sulfoxide in poor chemical and optical yield because of steric hindrance [15]. β -Carbonyl sulfides react at a rate comparable with that of their aromatic counterparts [16].

The sulfoxidation reaction catalyzed by CPO (Fig. 3) is likely to proceed via a direct oxygen transfer from compound I to the sulfide (Eq. (1)) or by a rebound mechanism involving the formation of compound II and a sulfenium radical cation (Eq. (3)). The recombination of these two species within the same cage of solvent would lead to the sulfoxide and to the native enzyme (Eq. (4)).

These CPO-catalyzed sulfoxidation reactions have been performed in aqueous buffer or aqueous

TABLE 1 Aryl Alkyl Sulfides Oxidation Catalyzed by CPO

<i>Sul de</i>	<i>Oxidant</i>	<i>Yield (%)</i>	<i>ee (%)</i>	<i>Control Reaction Yield (%)</i>
<i>p</i> -CH ₃ -C ₆ H ₄ -S-CH ₃	H ₂ O ₂	98	91	18
	<i>t</i> -BuOOH	80	70	24
<i>o</i> -CH ₃ -C ₆ H ₄ -S-CH ₃	H ₂ O ₂	27	33	13
	<i>t</i> -BuOOH	56	43	33
<i>p</i> -CH ₃ O-C ₆ H ₄ -S-CH ₃	H ₂ O ₂	72	90	16
	<i>t</i> -BuOOH	70	61	31
<i>o</i> -CH ₃ O-C ₆ H ₄ -S-CH ₃	H ₂ O ₂	24	27	23
	<i>t</i> -BuOOH	33	37	18
C ₆ H ₅ -S-CH ₃	H ₂ O ₂	100	98	30
	<i>t</i> -BuOOH	90	80	65
<i>p</i> -Cl-C ₆ H ₄ -S-CH ₃	H ₂ O ₂	77	90	13
	<i>t</i> -BuOOH	60	70	20
<i>o</i> -Cl-C ₆ H ₄ -S-CH ₃	H ₂ O ₂	33	85	13
	<i>t</i> -BuOOH	17	45	7
<i>p</i> -NO ₂ -C ₆ H ₄ -S-CH ₃	H ₂ O ₂	10	80	2
	<i>t</i> -BuOOH	16	80	2
<i>p</i> -CH ₃ -C ₆ H ₄ -S-C ₂ H ₅	H ₂ O ₂	50	68	15
	<i>t</i> -BuOOH	50	68	20
<i>p</i> -CH ₃ -C ₆ H ₄ -S- <i>n</i> -C ₃ H ₇	H ₂ O ₂	53	5	22
	<i>t</i> -BuOOH	30	5	28
<i>p</i> -CH ₃ -CO-NH-C ₆ H ₄ -S-CH ₃	H ₂ O ₂	86	67	23
	<i>t</i> -BuOOH	86	70	33
C ₆ H ₅ -CH ₂ -S-CH ₃	H ₂ O ₂	100	90	33
	<i>t</i> -BuOOH	73	55	50
2-pyridyl-S-CH ₃	H ₂ O ₂	100	99	26
	<i>t</i> -BuOOH	61	89	16
<i>p</i> -F-C ₆ H ₄ -S-CH ₃	H ₂ O ₂	100	97	27
	<i>t</i> -BuOOH	90	70	29

tert-butyl alcohol [17]. In situ generation of hydrogen peroxide from glucose and oxygen, with glucose oxidase and CPO coimmobilized in polyurethane foam, increased the turnover number, as recently shown by Sheldon and co-workers [18]. The stability of CPO could also be greatly increased in the oxidation of methyl phenyl sulfide to (*R*)-(-)-methyl sulfoxide by using dioxygen and either dihydroxyfumaric acid or ascorbic acid as external reductants. The reaction was carried out in a membrane reactor, which allowed the reuse of the enzyme for several conver-

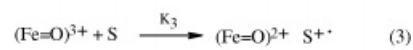
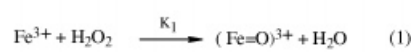
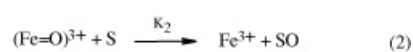
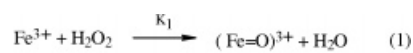

FIGURE 3 Mechanisms for oxygen-transfer in reactions catalyzed by CPO.

sions. A very high optical purity of the formed sulfoxide was observed as a consequence of the absence of aspecific oxidation of the substrate [19]. In conclusion, the differences in reactivity and enantioselectivity in the sulfoxidation reactions catalyzed by heme peroxidases can be explained by the differences in the environment of the active site. Heme peroxidases having a less accessible heme iron give lower enantioselectivity and reactivity; apart from HRP, these include microperoxidase-11, lactoperoxidase, and cytochrome *c* peroxidase.

Optically active epoxides are also very useful chiral synthons since they can undergo facile stereospecific ring opening to form bifunctional compounds. They are very important as key intermediates in the production of bioactive chiral compounds or as final products with biological activity. The development of practical methods for enantioselective epoxidation of unfunctionalized olefins is still an important challenge in the field of catalysis. Peroxidases can perform asymmetric epoxidation, but usually a low enantioselectivity is observed. In the past decade, however, tremendous progress has been achieved using CPO. CPO-catalyzed epoxidation is often accompanied by the formation of aldehydes as well as by allylic hydroxylation. In 1993 we had found that CPO is able to transfer enantioselectively an oxygen atom to styrene and styrene derivatives having a halogen atom in the aromatic ring [20]. *t*-BuOOH gave higher chemical yields with respect to hydrogen peroxide. The ee were in the range of 28–68% and the prevailing epoxide had the (*R*) absolute configuration. This was inferred to mean that the ferryl oxygen of compound **I** attacks the double bond from the side of the smaller substituent, in analogy to the attack at the sulfur atom in the sulfoxidation reaction. In the same year, Hager and Jacobsen studied the CPO-catalyzed epoxidation reaction of aliphatic olefins with hydrogen peroxide as oxidant [21]. They used disubstituted and trisubstituted alkenes. Very high enantioselectivity was observed with *cis*-substituted alkenes bearing alkyl substituents, whereas *trans*-olefins were found to be unreactive. The enzyme accepted branching in the alkyl substituent at the expense of lower chemical and optical reactivity. Certain trisubstituted alkenes were also accepted by CPO with moderate to good enantioselectivity. 1-Alkenes, with the exception of styrene derivatives, are suicide substrates that alkylate the heme in native CPO [22]. However, directed evolution of CPO by using a *Caldariomyces fumago* as an integrative vector system resulted in a fourth generation mutant of CPO that resists inactivation by terminal alkenes and hydrogen peroxide.

CPO mediates the epoxidation of a series of 2-methyl-1-alkenes [22] and of functionalized

alkenes such as ω -bromides [23], esters [24], and amides [25]. Again, the size of the substituents is the main limiting factor in terms of reactivity and enantioselectivity.

To prevent the hydrolysis of the formed epoxide, indene was oxidized in anhydrous glycerol, and this represents the first example of the use of CPO in a nonaqueous reaction medium [26].

In conclusion it may be stated that in comparison with other enzymatic and microbial epoxidation methods, the CPO-based system is more efficient; it accepts a broader range of substrates and catalyzes the epoxidation reaction with much higher enantioselectivity. CPO is, in this respect, highly complementary to the existing synthetic or biological catalysts that usually give poor optical yields in the formed epoxide. Another reaction that is common between CPO and cytochrome P-450 is the benzylic hydroxylation, which occurs with high enantioselectivity [27]. The mechanism of benzylic hydroxylation is likely a concerted process and not a two-step process involving hydrogen abstraction, followed by oxygen rebound.

CHMO from *Acinetobacter calcoaceticus* is a flavoenzyme of about 60,000 Da containing one non-covalently bound FAD unit per enzyme molecule. Its high versatility has been exploited in the manufacture of fine chemicals, based on the Baeyer–Villiger oxidation, which transforms racemic ketones into enantiomerically pure esters. The only reagents consumed are dioxygen, NADP(H), and the substrate ketone. According to the proposed mechanism, the actual oxidizing species should be the 4a-hydroperoxyflavin intermediate, acting as a nucleophile at the carbonyl carbon. Intramolecular elimination of water from 4a-hydroperoxyflavin would generate FAD for another catalytic cycle [28] (Fig. 4).

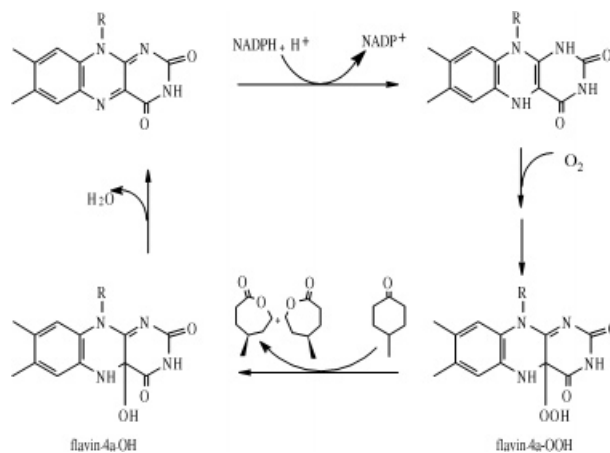
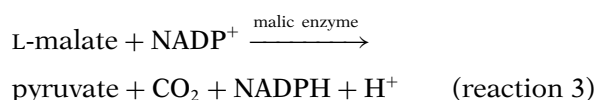
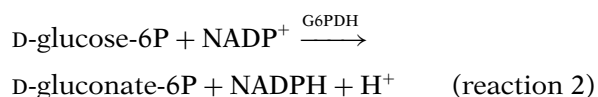
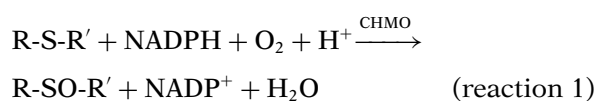

FIGURE 4 Catalytic cycle of CHMO.

CHMO can also oxygenate heteroatoms, because of the high reactivity of 4a-hydroperoxyflavin, which can behave also as an electrophile, for instance, to trimethyl phosphite and iodide ions.

Walsh and co-workers described the synthesis of (*S*)-ethyl-*p*-tolyl-sulfoxide (64% ee) using CHMO [29]. Our interest was to extend the investigation to various alkyl sulfides, in order to study the stereochemistry of oxidation at the sulfur atom [31] (Table 2).

The oxidation of sulfides by CHMO (reaction 1) was coupled to a second enzymatic reaction (reaction 2 or 3) in order to regenerate NADP(H).



The data reported in Table 2 clearly show that the stereochemical course of the reaction and the enantioselectivity are highly dependent on the substrate structure. Thus, for alkyl aryl sulfoxides the optical purity ranged from 99% ee of (*R*)-

methyl phenyl sulfoxide to 93% ee for (*S*)-ethyl-*p*-fluorophenylsulfoxide. The further oxidation of sulfoxides to the corresponding sulfones was very slow.

Similar results in terms of stereoselectivity were obtained with functionalized sulfides [31] and benzyl alkyl sulfides [32]. The use of macromolecular NADP(H) in a membrane reactor increased the efficiency of coenzyme recycling, the critical step of this biotransformation [33].

The stereoselectivity of the sulfoxidation and the absolute configuration of all the obtained products have been explained by us by proposing an active site model of the enzyme [34] (Fig. 5). Interestingly, the same model applies to Baeyer-Villiger oxidation [35].

1,3-Dithioacetal monosulfoxides are useful chiral acyl anion equivalents, extremely effective for imparting stereocontrol in enolate alkylation and amination, Mannich reactions and so on. We have extended the repertoire of CHMO to the enantioselective oxidation of 1,3-dithioacetals [36]. We have found that the CHMO-catalyzed oxidation of 1,3-dithiane, 1,3-dithiolane, and bis(methylthio)methane, chosen as model compounds, gives enantiomerically pure (*R*)-monosulfoxides in 81–84% chemical yield. Both asymmetric synthesis and kinetic resolution are at work for 1,3-dithiane and bis(methylthio)methane, whereas only asymmetric synthesis is operating in the case of 1,3-dithiolane. CHMO compares favorably with the chemical and other biochemical methods that afford monosulfoxides with ees ≤ 24 [36].

The main limitation of the exploitation of CHMO as a catalyst is the low stability of the isolated enzyme and the need for recycling the expensive

TABLE 2 Alkyl Aryl Sulfides Sulfoxidation Catalyzed by CHMO

Sul de	Yield (%)	ee (%)	Absolute Configuration
C ₆ H ₄ -S-CH ₃	88	99	<i>R</i>
<i>p</i> -F-C ₆ H ₄ -S-CH ₃	91	92	<i>R</i>
<i>o</i> -CH ₃ -C ₆ H ₄ -S-CH ₃	90	87	<i>R</i>
2-pyridyl-S-CH ₃	86	87	<i>R</i>
<i>p</i> -C ₂ H ₅ O-C ₆ H ₄ -S-CH ₃	92	59	<i>R</i>
C ₆ H ₄ -CH ₂ -S-CH ₃	97	54	<i>R</i>
<i>o</i> -CH ₃ -C ₆ H ₄ -S-CH ₃	81	51	<i>R</i>
C ₆ H ₄ S-C ₂ H ₅	86	47	<i>R</i>
<i>m</i> -CH ₃ -C ₆ H ₄ -S-CH ₃	90	40	<i>R</i>
<i>o</i> -Cl-C ₆ H ₄ -S-CH ₃	35	32	<i>R</i>
C ₆ H ₄ -S- <i>i</i> -C ₃ H ₇	93	3	<i>S</i>
<i>p</i> -CH ₃ -C ₆ H ₄ -S-CH ₃	94	37	<i>S</i>
<i>p</i> -Cl-C ₆ H ₄ -S-CH ₃	78	51	<i>S</i>
<i>p</i> -CH ₃ O-C ₆ H ₄ -S-CH ₃	89	51	<i>S</i>
<i>p</i> -CH ₃ -C ₆ H ₄ -S- <i>i</i> -C ₃ H ₇	99	86	<i>S</i>
<i>p</i> -CH ₃ -C ₆ H ₄ -S-C ₂ H ₅	89	89	<i>S</i>
<i>p</i> -F-C ₆ H ₄ -S-C ₂ H ₅	96	93	<i>S</i>
<i>t</i> -C ₄ H ₉ -S-CH ₃	98	99	<i>R</i>
C ₄ H ₉ -S-S-C ₄ H ₉	85	32	ND ^a
CH ₃ -S-S-C ₃ H ₇	92	64; 34 ^b	ND

^aND: not determined.

^bFor the two regioisomeric thiosulfonates.

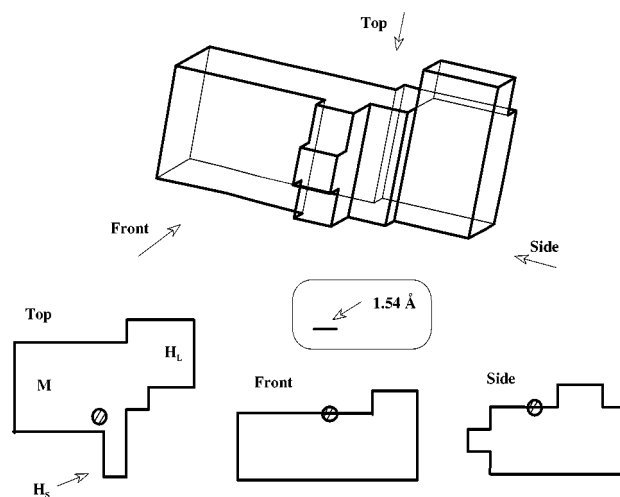

FIGURE 5 Active site model of cyclohexanone mono-oxygenase.

NADP(H) coenzyme. This problem, however, can be circumvented by using whole cell of *Acinetobacter calcoaceticus* [37]. For example, 1,3-dithiane was efficiently oxidized in a preparative scale experiment to (*R*)-1,3-dithiane oxide with 98% ee, as a result of both asymmetric synthesis and kinetic resolution, which is in agreement with the results previously obtained with the isolated enzyme.

There is a relative paucity in the literature, of general one-step procedures for obtaining enantiomerically pure dialkyl sulfoxides. This shows the importance of the new enzymatic enantioselective synthesis of dialkyl sulfoxides catalyzed by CPO and CHMO recently described by our group [38].

Both enzymes exhibit high enantioselectivity in the oxidation of cycloalkyl and alkyl methyl sulfides with limited steric requirements. The CPO always leads to the (*R*)-sulfoxides; the two-enzymatic systems are enantiocomplementary for pentyl methyl sulfide and for octyl methyl sulfide, leading in all other cases to the (*R*)-sulfoxides.

CHMO also catalyses the asymmetric oxidation of *tert*-butyl disulfide to the enantiomerically pure (*R*)-*tert*-butanethiosulfinate [39], an excellent chiral auxiliary for a range of chiral sulfinimines, which can be transformed into α -branched amines, α,α -dibranched amines, α - and β -amino acids, and α - and β -aminophosphonic acids. Lower enantioselectivities and conversions were observed in the oxidation of *i*-propyl, *n*-propyl, *p*-tolyl *tert*-butyl disulfides, and alkylthiophosphonates.

CONCLUSIONS

CPO, being a heme-peroxidase-cytochrome P-450 functional hybrid [12], outclasses all other peroxidases and is able to perform enantioselective sulfoxidation, hydroxylation, and epoxidation reactions.

CHMO from *Acinetobacter calcoaceticus* has a higher versatility in the oxidation at sulfur atom as it accepts a much larger range of substrates. Research is in progress to extend its use to the enantioselective oxidation of other prostereogenic sulfur derivatives and to the epoxidation of olefins (unpublished results from this laboratory) thus extending its synthetic repertoire.

REFERENCES

- Colonna, S.; Gaggero, N.; Richelmi, C.; Pasta, P. *Tibtech* 1999, 17, 163–168.
- Faber, K. *Biotransformations in Organic Chemistry*, 4th ed.; Springer-Verlag: Berlin, 2000 and references cited therein.
- Gajhede, M.; Schuller, D. J.; Enriksen, A.; Smith, A. T.; Poulos, T. L. *Nat Struct Biol* 1997, 4, 1032–1038.
- Mikolajczyk, M.; Drabowicz, J.; Kielbasinski, P. *Chiral Sulfur Reagents; Applications in Asymmetric and Stereoselective Synthesis*; CRC Press: Boca Raton, 1997.
- Colonna, S.; Gaggero, N.; Carrea, G.; Pasta, P. *J Chem Soc, Chem Commun* 1992, 357–358.
- Ozaki, S.; Ortiz de Montellano, P. R. *J Am Chem Soc* 1995, 117, 7056–7064.
- Neidleman, S. L.; Geigert, J. *Biohalogenation: Principles, Basic Roles and Applications*; Ellis Horwood: Chichester, 1986; 105–112.
- Van Deurzen, M. P. J.; Seelbach, K.; Van Rantwijk, F.; Sheldon, R. A. *Biocatal Biotransform* 1997, 15, 1–16.
- Corbett, M. D.; Chipko, B. R.; Batchelor, A. O. *Biochem J* 1980, 187, 893–903.
- Miller, V. P.; Tschirret-Guth, R. A.; Ortiz de Montellano, P. R. *Arch Biochem Biophys* 1995, 319, 333–340.
- Hu, S.; Hager, L. P. *J Am Chem Soc* 1999, 121, 872–873.
- Sundaramoorthy, M.; Turner, J.; Poulos, T. L. *Structure* 1995, 3, 1367–1377.
- Seelbach, K.; Van Deurzen, M. P. J.; Van Rantwijk, F.; Sheldon, R. A.; Kragl, U. *Biotechnol Bioeng* 1997, 55, 283–288.
- (a) Colonna, S.; Gaggero, N.; Manfredi, A.; Casella, L.; Gulotti, M.; Carrea, G.; Pasta, P. *Biochemistry* 1990, 29, 10465–10468; (b) Colonna, S.; Gaggero, N.; Casella, L.; Carrea, G.; Pasta, P. *Tetrahedron: Asymmetry* 1992, 3, 95–106.
- Allenmark, S. G.; Andersson, M. A. *Chirality* 1998, 10, 246–252.
- Vargas, R. R.; Bechara, E. J. H.; Marzorati, L.; Wladislaw, B. *Tetrahedron: Asymmetry* 1999, 10, 3219–3227.
- Van Deurzen, M. P. J.; Van Rantwijk, F.; Sheldon, R. A. *Tetrahedron* 1997, 53, 13183–13220.
- Van de Velde, F.; Lourenço, N. D.; Bakker, M.; Van Rantwijk, F.; Sheldon, R. A. *Biotechnol Bioeng* 2000, 69, 286–291.
- Pasta, P.; Carrea, G.; Monzani, E.; Gaggero, N.; Colonna, S. *Biotechnol Bioeng* 1999, 62, 489–493.
- Colonna, S.; Gaggero, N.; Casella, L.; Carrea, G.; Pasta, P. *Tetrahedron: Asymmetry* 1993, 4, 1325–1330.
- Allain, A. J.; Hager, L. P.; Deng, L.; Jacobsen, E. N. *J Amer Chem Soc* 1993, 115, 4415–4416.
- Dexter, A. F.; Lakner, F. J.; Campbell, R. A.; Hager, L. P. *J Am Chem Soc* 1995, 117, 6412–6413.
- Lakner, F. J.; Cain, K. P.; Hager, L. P. *J Am Chem Soc* 1997, 119, 443–444.
- Lakner, F. J.; Hager, L. P. *J Org Chem* 1996, 61, 3923–3925.
- Lakner, F. J.; Hager, L. P. *Tetrahedron Asymmetry* 1997, 8, 3547–3550.
- Manoj, K. M.; Lakner, F. J.; Hager, L. P. *J Mol Catal B-Enzymatic* 2000, 9, 107–111.
- Zaks, A.; Dodds, D. R. *J Am Chem Soc* 1995, 117, 10419–10424.
- Walsh, C. T.; Chen, Y. C. *J. Angew Chem, Int Ed Engl* 1988, 27, 333–343.
- Light, D. R.; Waxman, D. J.; Walsh, C. *Biochemistry* 1982, 21, 2490–2498.

- [30] Carrea, G.; Redigolo, B.; Riva, S.; Colonna, S.; Gaggero, N.; Battistel, E.; Bianchi, D. *Tetrahedron: Asymmetry* 1992, 3, 1063–1068.
- [31] Secundo, F.; Carrea, G.; Dallavalle, S.; Franzosi, G. *Tetrahedron Asymmetry* 1993, 4, 1981–1982.
- [32] Pasta, P.; Carrea, G.; Holland, H. L.; Dallavalle, S. *Tetrahedron: Asymmetry* 1995, 6, 933–936.
- [33] Secundo, F.; Carrea, G.; Riva, S.; Battistel, E.; Bianchi, D. *Biotechnol Lett* 1993, 15, 865–870.
- [34] Ottolina, G.; Pasta, P.; Carrea, G.; Colonna, S.; Dallavalle, S.; Holland, H. L. *Tetrahedron: Asymmetry* 1995, 6, 1375–1386.
- [35] Ottolina, G.; Carrea, G.; Colonna, S.; Rückermann, A. *Tetrahedron: Asymmetry* 1996, 7, 1123–1136.
- [36] Colonna, S.; Gaggero, N.; Bertinotti, A.; Carrea, G.; Pasta, P.; Bernardi, A. *J Chem Soc, Chem Commun* 1995, 1123–1124.
- [37] Alphand, V.; Gaggero, N.; Colonna, S.; Pasta, P.; Furstoss, R. *Tetrahedron* 1997, 53, 9695–9706.
- [38] Colonna, S.; Gaggero, N.; Carrea, G.; Pasta, P. *J Chem Soc, Chem Commun* 1997, 439–440.
- [39] Colonna, S.; Gaggero, N.; Carrea, G.; Pasta, P.; Alphand, V.; Furstoss, R. *Chirality* 2001, 13, 40–42.